

# Pulsar™ EX20 / EX30 EXB20/30

Manuel d'utilisation

User Manual

Manual de instrucciones

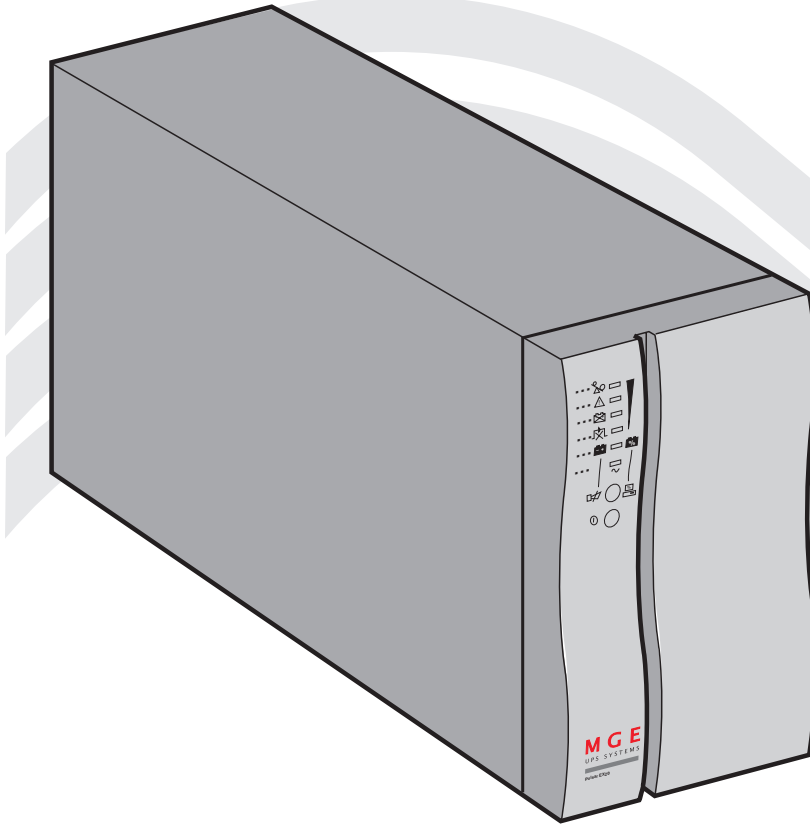

**MGE**  
UPS SYSTEMS

---

Thank you for purchasing the **EX** Uninterruptible Power Supply. The **EX** has been designed to provide many years of trouble-free operation. Please review the manual which has been prepared to provide you with all the necessary information concerning the installation and use of your **EX**.

For service call 1-800-523-0142.

Sincerely,

**MGE UPS SYSTEMS**

Nous vous remercions pour l'achat de l'Alimentation sans interruption **EX**. Nous vous invitons à lire ce manuel en souhaitant qu'il apporte tous les éléments nécessaires à l'installation et à l'utilisation de votre onduleur **EX**.

Appelez le numéro de téléphone 714-513-7349.

Nous vous prions d'agréer, Madame, Monsieur, nos sentiments les meilleurs.

**MGE UPS SYSTEMS**

Le agradecemos la compra del SAI **EX**. Lo invitamos a leer este manual esperando que éste le brindará todos los elementos necesarios para la instalación y la utilización de su SAI **EX**.

Contáctenos al siguiente número de teléfono 714-513-7349.

Le saludamos a Ud. muy cordialmente.

**MGE UPS SYSTEMS**

---

## Federal Communications Commission (FCC) Statement

**Note:** this equipment has been tested and found to comply with Part 15 of the FCC Rules. These limits are designed to provide reasonable protection against harmful interference when equipment is operated in a residential environment. This equipment generates, uses and can radiate radio frequency energy and, if not installed and used in accordance with the instruction manual, may cause harmful interference to radio communications. Properly shielded and grounded cables and connectors must be used in order to meet FCC emission limits.

---

## note

■ this equipment has been tested and found to comply with Part 15 of the FCC Rules. These limits are designed to provide reasonable protection against harmful interference when the equipment is operated in a commercial environment. This equipment generates, uses, and can radiate radio frequency energy and, if not installed and used in accordance with the instruction manual, may cause harmful interference to radio communications. Operation of this equipment in a residential area is likely to cause harmful interference in which case the user will be required to correct the interference at his own expense.

## service and factory repair - call 1 - 800 - 523 - 0142

■ direct questions about the operation, repair, or servicing of this equipment to MGE UPS SYSTEMS, Inc. Customer Support Services. Include the part number, assembly number, and serial number of the unit in any correspondence. Should you require factory service for your equipment, contact MGE UPS SYSTEMS, Inc. Customer Support Services and obtain a Return Materials Authorization (RMA) prior to shipping your unit. Never ship equipment to MGE UPS SYSTEMS, Inc. without first obtaining an RMA.

## proprietary rights statement

■ the information in this manual is the property of MGE UPS SYSTEMS, Inc., and represents a proprietary article in which MGE UPS SYSTEMS, Inc., retains any and all patent rights, including exclusive rights of use and/or manufacture and/or sale. Possession of this information does not convey any permission to reproduce, print, or manufacture the article or articles shown herein. Such permission may be granted only by specific written authorization, signed by an officer of MGE UPS SYSTEMS, Inc.;

■ IBM, PC-AT, ES/9000, and AS/400 are trademarks of International Business Machines Corporation. Other trademarks that may be used herein are owned by their respective companies and are referred to in an editorial fashion only.

## two years warranty policy

■ MGE UPS SYSTEMS, Inc. (herein after referred to as MGE) warrants **Topaz** and **Pulsar** equipment manufactured by MGE to be free from defects in materials and workmanship for a period of two years from date of purchase. If within such period purchaser discovers defective item and promptly notifies MGE in writing, MGE shall repair or replace the item at the Company's option. This warranty shall not apply:

to equipment not manufactured by MGE,

to equipment repaired or altered by others than MGE,

to equipment subjected to negligence, accident, or damage by circumstances beyond MGE's control, or to improper operations, maintenance, or storage, or to other than normal use or service.

With respect to equipment not manufactured by MGE, the Warranty obligations of MGE shall in all respects conform and Warranties do not cover reimbursement for labor, transportation, removal, installation, or other expenses which may be incurred in connection with repairs or replacement. Except as may be expressly provided in an authorized writing by MGE, MGE shall not be subject to any other obligations or liabilities whatsoever with respect to equipment manufactured by MGE or service rendered by MGE. After Sales Service Support Line: 1-800-523-0142.

---

**MGE UPS SYSTEMS, Inc.**

**Postal address:**

1660 Scenic Avenue  
Costa Mesa, CA 92626  
714-557-1636

**51032278XT/AB**

---

# ENGLISH

## IMPORTANT SAFETY INSTRUCTIONS SAVE THESE INSTRUCTIONS

This manual contains important instructions for Models EX20 / EX30 / EXB20/30 that should be followed during installation and maintenance of the UPS batteries.

■ This equipment can be operated by any individual, with no previous training;

■ **CAUTION:** Risk of electric shock, even with unit disconnected from AC power source. Hazardous voltage still may be present through operation from battery. The battery supply should be disconnected at the plus and minus terminals using the quick disconnect connectors of the battery when maintenance or service work inside the UPS is necessary.

■ **The UPS contains voltages which are potentially hazardous. All repairs should be performed by qualified service personnel only;**

■ **do not attempt to power the UPS from any receptacle other than a 2-pole 3-wire grounded receptacle;**

■ do not place **Pulsar** near water or in environment of excessive humidity;

■ do not allow liquids or any foreign objects to get inside **Pulsar**;

■ do not block air vents in the back of **Pulsar**;

■ do not plug household appliances such as hair dryers to **Pulsar** receptacles;

■ do not place **Pulsar** in direct sunlight or close to heat-emitting source;

■ the AC power receptacle should be near the equipment and easily accessible. To isolate **Pulsar** from AC input, remove the input power cord from the AC power receptacle;

■ if **Pulsar** is to be stored for a long time, it is recommended to recharge the batteries (by connecting AC power source to **Pulsar**, switch "ON" or "OFF"), once a month for 24 hours to avoid a full batteries discharge;

■ **Pulsar** contains batteries that should be disposed of or recycled in accordance with local applicable laws;

■ prior to installation, store **Pulsar** in a dry location;

■ storage temperatures must be between -4°F (-20°C) and +113°F (+45°C);

■ servicing of batteries should be performed or supervised by personnel knowledgeable of batteries and the required precautions. Keep unauthorized personnel away from batteries;

■ when replacing the batteries, use the same number and the following type of batteries:

□ **Pulsar EX20:** 8 x 12V - 6.5Ah,

□ **Pulsar EX30:** 8 x 12V - 7.2Ah;

■ ~ : alternating current supply symbol;

■ **CAUTION:** do not dispose of battery or batteries in a fire. The battery may explode;

■ **CAUTION:** do not open or mutilate the battery or batteries, released electrolyte is harmful to the skin and eyes. It may be toxic;

■ **CAUTION:** a battery can present a risk of electric shock and high short circuit current.

The following precautions should be observed when working with batteries:

□ remove watches, rings or other metal objects,

□ use tools with insulated handles,

□ wear rubber gloves, boots and safety glasses;

■ please dispose of the packaging in accordance with the applicable legislation.

# ENGLISH

## introduction

In critical situations, count on MGE UPS SYSTEMS **Pulsar EX20** and **EX30** uninterruptible power supplies (UPS). Their protection keeps your data intact and accessible.

**Pulsar EX20** and **EX30** UPSs ensure top quality power around the clock, and continue operations during power failures. An intelligent microprocessor detects any operating anomalies of the UPS and triggers an alarm if corrective action is necessary. In addition to the high-technology aspect of these UPSs, you can count on backup from our staff, a team of specialists, around the corner from you, throughout the world. It's no accident that MGE UPS SYSTEMS is the world leader in UPS protection. The UPS shall provide power factor correction to prevent harmonic distortions and current created by non-linear critical loads from polluting the incoming AC line.

UPS includes:

- batteries,
- power factor correction / battery charger,
- DC to DC converter,
- DC to AC Converter,
- bypass switch,
- input/output filters.

The MGE **Pulsar** UPS is capable of providing the following modes of operation:

- **ON LINE MODE** which is the primary mode of operation in which the critical load is continuously supplied by the inverter and protected from all forms of power line disturbances:

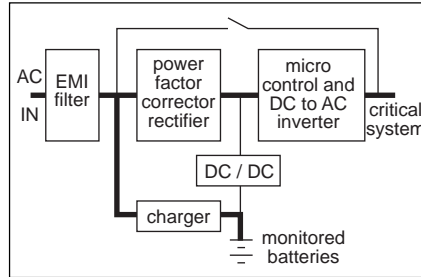

- **BYPASS MODE** which is a default mode in the event of an inverter failure or overload in which the critical load is supplied AC through EMI/RFI filter:

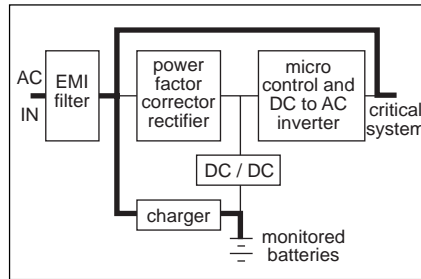

### application of Pulsar EX20 and EX30:

Network servers and interconnection devices are very sensitive to electrical disturbances of all types, including outages, voltage sags, brownouts, spikes, etc. The origins of the disturbances also vary,

ranging from atmospheric phenomena, to nearby devices generating interference such as elevators, photocopy machines and machine tools, not to mention human errors, like the accidental pulling out of power cords or tripping of circuit breakers. The consequences of these disturbances on computer systems range from data losses to hardware damage (power supplies, hard disks).

**Pulsar EX20** and **EX30** are specially designed to protect network servers and all other interconnection devices that are sensitive to electrical disturbances.

**Pulsar EX20** and **EX30** add fault-tolerance to the utility supplying your sensitive equipment.

**Pulsar EX20** and **EX30** are designed as compact units and feature very quiet operation. They can be installed under a desk, and can also be installed in a rack (see "options").

**Pulsar EX20** and **EX30** provide a stable supply of clean power, long back-up time during a utility outage (see table) and vast information and control possibilities according to the configuration selected.

**Pulsar EX20** and **EX30** On-Line technology provides maximum protection and availability of your workstations, server, and network communication devices.

**Pulsar EX20** and **EX30** offer many functions and characteristics designed to simplify power management:

- automatic battery test carried out periodically. In the event of a fault, a LED provides advance warning for battery replacement;

- front panel LEDs signal all types of faults and alarms;
- Bar graph continuously indicates the battery charge level or the critical load power level;
- **Pulsar EX20 and EX30** are environment friendly: all components are recyclable and an electronic power-saver device reduces power consumption if the UPS is not active for a period exceeding 5 minutes while on battery back-up;
- EX Driver software provides rapid startup of **Pulsar EX20 and EX30** using the EX Tuner configuration module. This module adapts **Pulsar EX20 and EX30** to user preferences (battery test frequency, startup and shutdown sequences, setting of battery thresholds, etc.). Operation and monitoring are ensured by the UPS Manager 3.1 module operating under Windows 3.1. EX Driver connects to the RS 232 port on the **Pulsar EX20 and EX30** (see "communication" section for further details);
- Solution-Pac™ is a CD-ROM which contains all the tools needed to supervise your UPS.

## options

- **rack installation kit:** this kit is used to install **Pulsar EX20 and EX30** in a 19-inch rack;
- **UM Sensor environment measurement unit:** compatible with SNMP and UPS Manager 2 Unix and OS/2, or Solution Pac™, this unit measures the temperature and the relative humidity in the room where the **Pulsar** is installed. Eight relay contacts are provided to transmit signals to an administration platform, in the form of voltage-free contacts to enable monitoring of (fire alarm, climate control fault, intrusion, etc.);
- **battery extension module:** **Pulsar EXB20/30** battery extension modules lengthen the battery time of the **Pulsar EX20/EX30** to meet your requirements;
- **isolation transformer:** input line cord plugs into the **Pulsar EX30** output receptacle. Rating is 120V AC input, 208V/240V AC 2.75 kVA output;
- **maintenance bypass switch:** enables the user to continue supplying ac power to the load while performing routine or emergency maintenance.

## additional communications options:

- **communication cables:** these cables are used for the file-closing utilities offered by a number of network operating systems. They are available for Novell NetWare, Microsoft Lan Manager and Windows NT, IBM Lan Server, Artisoft LANtastic, Banyan Vines, Apple System 7, IBM AS400 and many others;

- **UPS Manager 2 communication software:** this software can be used for automatic file closing on one or more servers, as well as for remote UPS shutdown and interrogation of all **Pulsar EX20 and EX30** operating parameters. It is available for Novell NetWare, Microsoft Lan Manager, IBM Lan Server, the main Unix systems on the market (SCO, AIX, HP/UX, OSF 1, etc.) VAX UMS and many others;
- **SNMP administration:** Merlin Gerin has the most complete offering for the administration of a group of UPSs using the SNMP protocol with different network-connection modules (UM Link adaptor or proxy UM Agent software), supervision modules (dedicated software under Windows UM View or application for NMS platforms such as HP OpenView or Novell NMS) and a file-closing module (UM Client). The MGE UPS SYSTEMS offering complies with RFC 1628 specifications (IETF) and was certified by the InterWorking Labs during the Test Summit in June 1994;
- **SNMP card:** this card, inserted into your unit, makes your UPS SNMP-compatible in any environment;
- **status information card:** this option provides you with 5 voltage-free contacts: on battery, on by-pass, low battery, load on UPS.

Contact your dealer for further information on these options.

---

## software supplied with Pulsar EX20 and EX30

To meet the different operating environments of your UPS, **Pulsar EX** includes 2 MGE UPS SYSTEMS software programs:

- **EX-Driver** software for Windows (on 3.5" diskettes);
- **Solution-Pac™** network software (on CD-ROM).

### EX-Driver for Windows

EX Driver for Windows provides communication with the UPS from a simple Windows workstation. EX-Driver is compatible with Windows 3.1x and Windows 95, for communication with the UPS via a serial connection for various needs:

- **personalization of the UPS operating mode:** the EX-Tuner utility, can be used to change certain UPS operating parameters if the standard factory settings are not ideal for the operating conditions.

It is possible to modify the output voltage, battery-test frequency, startup and shutdown sequences, operation of automatic by-pass, etc.;

- **UPS monitoring from a Windows workstation and system safety:**

EX-Driver, UPS Manager 3 software, can display the UPS status, warn the user if a problem arises, and provide automatic shutdown.

The many possibilities available include:

- supervision of operating parameters through a graphic interface (display of battery charge level, remaining battery time and UPS load level). These values can be recorded periodically in a log file,
- messages to the user in case of power

outage or UPS problem and recording of events in a log file,

- during long-term power outages, automatic shutdown of the system and of the UPS, followed by automatic restart of the UPS (system reboot) on return of utility power,
- PowerShare™ functions.

### Solution-Pac™ for networks and multi-station systems

Novell Netware, Windows NT, OS/2 Lan Server, SCO Unix, etc.)

Protection by UPS is only complete and effective if combined with powerful software functions which warn users and the operator of any power supply problem, automate system shutdown, supervise and remotely control the UPSs. MGE UPS SYSTEMS created Solution-Pac™ for this purpose. Solution-Pac™ combines all these functions in a single CD-ROM, usable in local or remote mode (SNMP), and covering the main network environments.

Solution-Pac™ is the ideal solution for protecting networks and multistation systems.

Solution-Pac™ on a single CD-ROM contains everything needed to safeguard one or more systems and to supervise one or more UPSs from a local or remote station. Solution-Pac™ includes SNMP UM-Agent, UM-Client system shutdown software, and UM-Console supervision software.

Solution-Pac™ is a powerful and upgradable software tool which provides all the supervision, control and safety functions

associated with a UPS:

- graphic display of the UPS,
- remote control of the UPS and output receptacles,
- user alarm of problems,
- recording of events in log files,
- automatic system shutdown and restart,
- local or remote supervision of UPSs and ancillary devices,
- transmission of UPS information and alarms to any SNMP supervisor.



---

<b>Pulsar presentation</b> .....	<b>3</b>
<b>présentation de Pulsar</b>	
<b>presentación de Pulsar</b>	
<b>english</b> .....	<b>11</b>
getting started / operation	
<b>français</b> .....	<b>19</b>
mise en service / exploitation	
<b>español</b> .....	<b>27</b>
puesta en servicio / explotación	

---

**Pulsar EX20/EX30**  
front view / vue avant / vista delantera

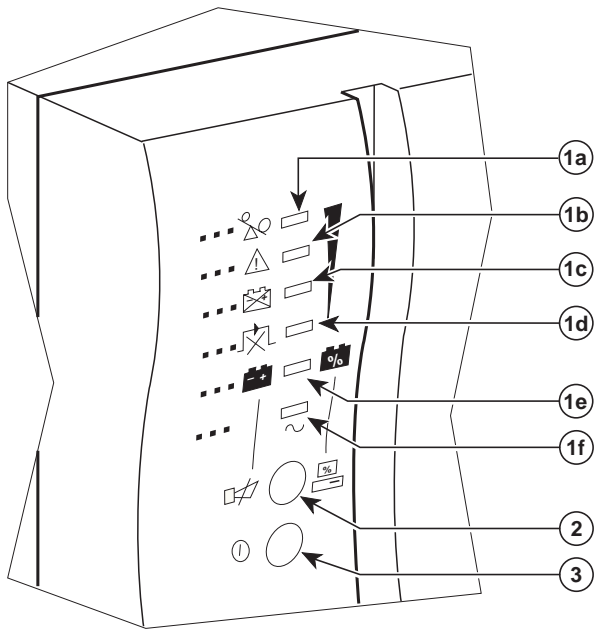

**Pulsar EX20/EX30**  
rear view / vue arrière / vista trasera

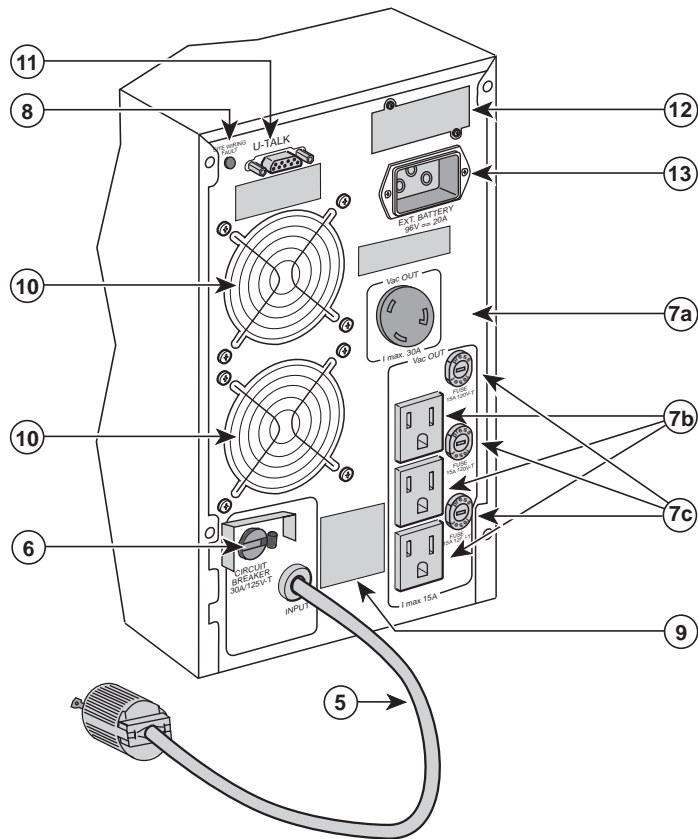

**Pulsar EXB20/30**  
rear view / vue arrière / vista trasera

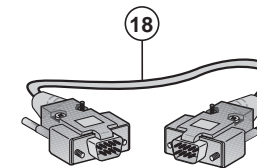
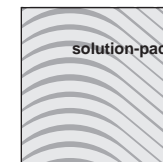
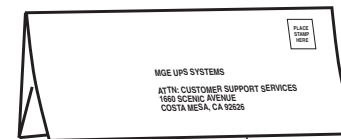
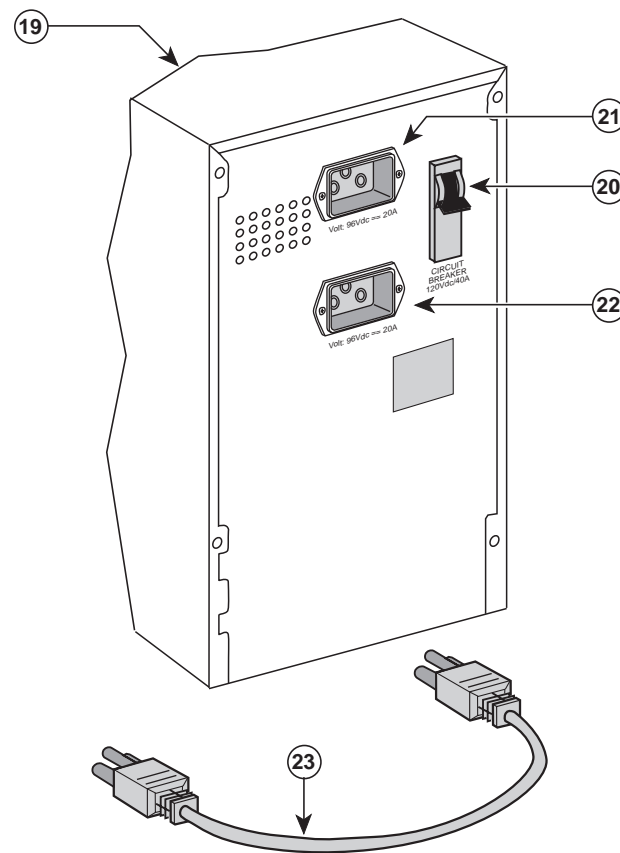

# contents

---

- getting started** ..... 12
- location ..... 12
- preliminary checks ..... 12
- connections ..... 12
- communication ..... 13
  
- operation** ..... 14
- starting up with utility power present ..... 14
- starting up with out utility power ..... 15
- operation on battery ..... 16
- overload ..... 17
- operating anomalies ..... 17

---

# getting started

## location

■ observe the safety rules indicated at the beginning of this document.

## preliminary checks

■ check that the "on/off" button "I" on the front is not pushed in;  
■ check that rating shown on the rating label corresponds to the input voltage specification and power requirement of the load.

## connections

■ connect the AC input cord to the utility power outlet.

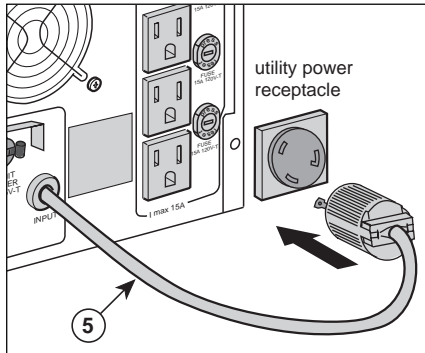

■ connect the computer loads to output sockets 7a or 7b.

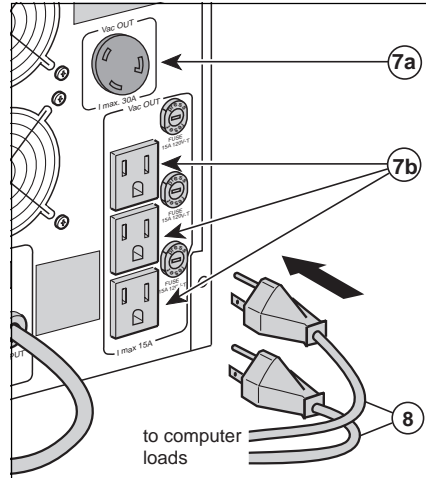

**Note 1:** following connection, the battery automatically charges, whenever plugged in.

**Note 2:** the batteries will provide full back-up time after approximatively 8 hours of recharge time.

**Note 3:** if site wiring fault LED 8 is lit and buzzer sounds, line/neutral connections are reversed.

■ connection of the Pulsar EXB20/30 battery extension module (optional):

- check that the button "on/off" "I" on the front of the Pulsar EX20/EX30 is not pushed in,
- disconnect the input connection cord,
- flip the circuit-breaker of the battery unit to the right (position "O"),
- connect the battery connection cord to the DC connector of the battery module and connect to the Pulsar EX20/EX30,
- if the installation has 2 battery modules, connect the second cord to the DC connector of the second module and to the first module,
- the use of connectors is strictly limited to connecting the battery modules to the Pulsar EX20/EX30. Any other connection to these connectors is prohibited and risks damaging the battery, not covered by warranty,
- to start, flip the battery circuit-breaker to the left (position "I"),
- if your installation is operated with MGE UPS SYSTEMS software, update your battery configuration with EX Tuner.

## communication

■ the U-Talk communication port, at the rear of the **Pulsar**, delivers information in the form of an RS232 series link supported by the communication protocol exclusive to MGE UPS SYSTEMS. The Solution-Pac™ programs use the data made available by this protocol.

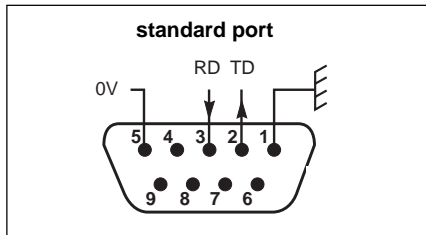

With the EX Driver software program you can set up **Pulsar EX** to suit your user conditions (EX Tuner), supervise your UPS and safeguard your system (UPS Manager 3.1). To install EX Driver, connect the serial cable supplied to COM1 to COM4 (set up by EX Tuner) series port of your computer equipped with Windows 3.1 on the one end, and to the serial **Pulsar EX** connector on the other end. Insert the disk and type A:\install. Follow the installation instructions on the screen. You may then use 2 software programs :

- EX Tuner to set up **Pulsar EX**,
- UPS Manager 3.1 to supervise and safeguard your system.

## option 1

■ **status information card**: after the card is installed in the rear of the **Pulsar**, communication port transmits the status information on a SUB-D 9-pin female connector using the following pinouts:

- 1 - ground,
- 2 - remote power off,
- 4 - normal operation,
- 5 - common,
- 6 - operation on utility power,
- 7 - low battery warning,
- 8 - load supplied by UPS,
- 9 - operation on battery.

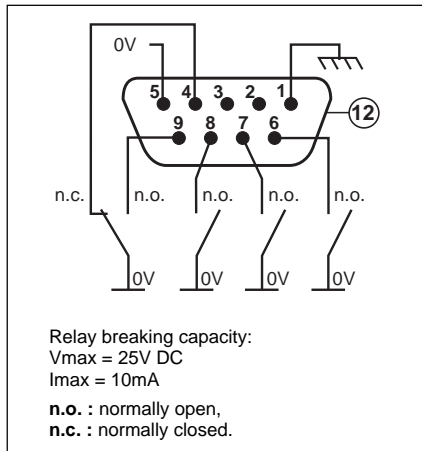

### Note for remote power off information:

Remove first J1 jumper on the status information board, then link your remote power off switch S1 between pins 2 and 5. Follow instructions from user's manual of the

optional board for installation.

- switch ON: normal operation,
- switch OFF: unit stops immediately.

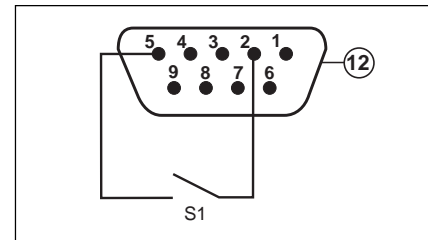

## option 2

■ **SNMP card**: after the card is installed in the rear of the **Pulsar**, the communication port transmits information supported by the SNMP protocol on an RJ45 or BNC connector.

Contact your sales agent for further details.

# operation

## starting up with utility power present

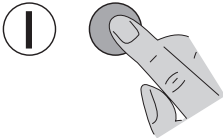

press button "on/off" :

automatic sequence:

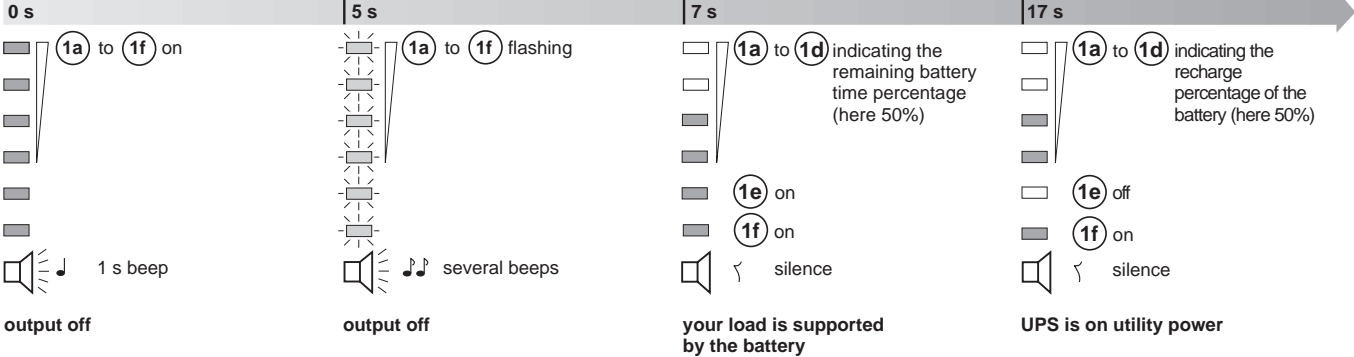

# starting up with out utility power

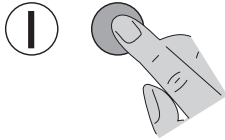

press "on/off" button:

indicator lights test

device and battery test

normal operation on battery

*automatic sequence:*

0 s

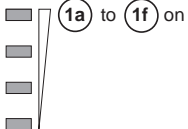

output off

5 s

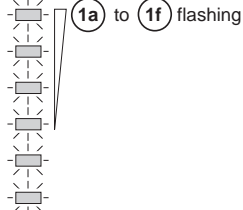

output off

7 s

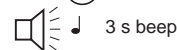
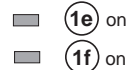
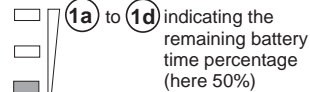

your load is supported by the battery

17 s

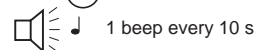
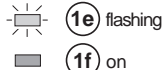
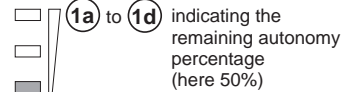

UPS is on utility power

## operation on battery no utility power

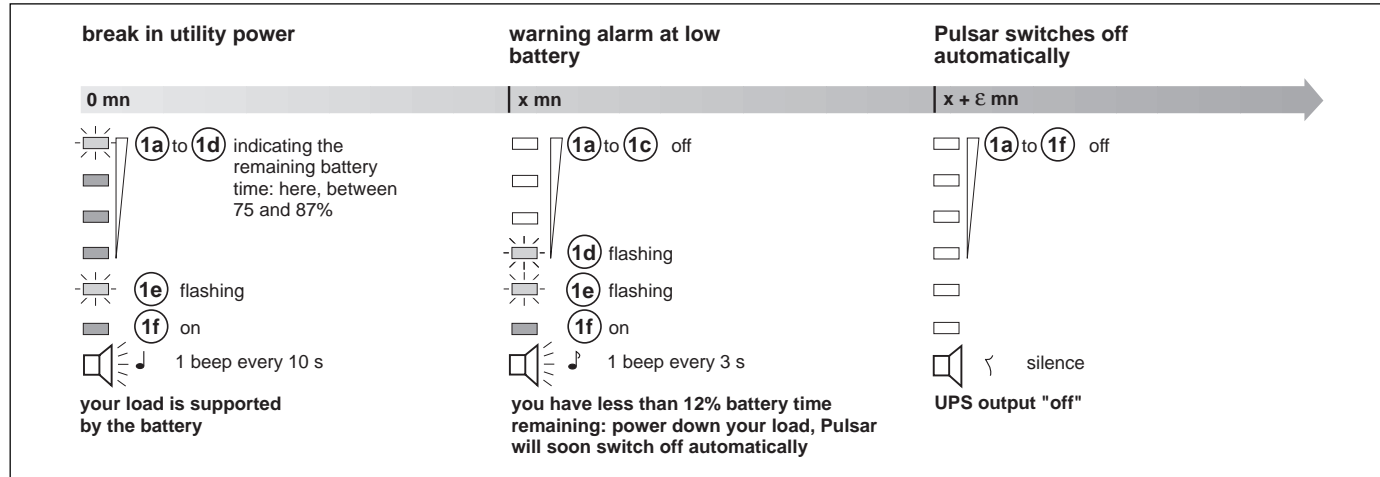

## return of utility power

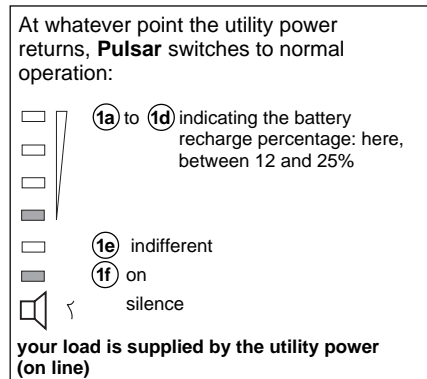

### Note 1:

The "function" button is to deactivate or activate the audio warning device when operating on battery, or when site wiring fault occurred.

### Note 2:

The "function" button allows you to force a transfer on bypass (push three times within 5 seconds) and to come back on normal operation (push again three times within 5 seconds).

## load charge percentage

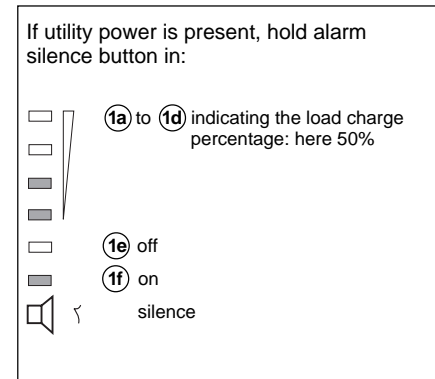



## overload utility power present

**1a** flashing  
**1d** flashing  
**1e** off  
**1f** on  
 1 beep every second  
**automatic load transfer to bypass**

## no utility power present

**1a** flashing  
**1e** flashing  
**1f** on  
 1 beep every second  
**Pulsar switches off automatically after a length of time which depends on the level of overload.**

**Note:** overload occurs if the load consumption is greater than the rated power of **Pulsar**.

To acknowledge the fault, release the "on/off" button, temporarily disconnected **Pulsar** from the wall socket (check input cord), disconnect loads and re-start **Pulsar**.

## operating anomalies device fault

**1b** flashing  
**1d** flashing  
**1e** off  
**1f** on  
 1 beep every second  

- **automatic load transfer to bypass,**
- switch off **Pulsar** (release "on/off" button), disconnect from the wall socket (check input cord), and check that **Pulsar** has not short-circuited (disconnect all loads),
- if necessary, change one of the fuses **7c**,
- re-start **Pulsar**.

## battery low

**1a** to **1f** off  
 ...continuous beep  
 after the start-up sequence, if the audio warning device sounds continuously,  
**recharge your battery for 8 hours.**

**Note:** if the previous symptoms persist, contact technical support.

## battery fault

A battery test is carried out while **Pulsar**, is in start-up mode, then automatically every 7 days (interval times adjustable using EX Driver). If a battery fault is detected, the following occurs:

**1c** flashing  
**1e** off  
**1f** on  
 1 beep every second  
**recharge your battery for 8 hours.**

## operation on bypass

**1a** and **1b** indifferents  
**1d** flashing  
**1e** off  
**1f** on  
 1 beep every second  
 see "overload" and "device fault" section

**Note:** This operating mode provides temporary inverter fault tolerance.

